

Gamme standard aluminium

Armoires outdoor



Concevoir. Produire. Livrer. Servir.

Créateur de solutions



Une solution parfaitement adaptée au complexe sportif

Alu

IP 44



Conception standard :

Alliage aluminium 5754 H22 Ep: 20/10.
Porte démontables avec arrêtoir et crémone à fermeture trois points.
Ventilations naturelles par chicanes hautes et basses.
Protection IP 44 IK 10.
Peinture poudre polyester RAL 1015 texturée.
Nota : serrure à définir selon vos besoin



alu

gamme standard



Légers et résistants

Garantie 10 ans anti-corrosion



Références, options et dimensions :



	Porte	Cote L*P*H	-1- Montants 19	-2- Panneau pivotant 1 porte	-2- Panneau pivotant 2 portes	-3- Platine de montage	-4- Rail	-5- Fond plein	-6- Fond avec passage de câbles	-7- Socle aluminium H 350 - 200	-8- Socle béton	Etanchéité IP 45	Kit anti Vandalisme	-11- Coffret ERDF encasté
FLX-0032146	1	600*300*1016				FLX-0014980	FLX-0015037	FLX-0042657				FLX-0015047	FLX-0015099	
FLX-0032147	1	800*300*1016				FLX-0014982	FLX-0015037	FLX-0015111		FLX-0026983		FLX-0015048		
FLX-0032148	1	600*410*1016		FLX-0014959		FLX-0014980	FLX-0015037		FLX-0035986	FLX-0045255 FLX-0035985 FLX-0015154		FLX-0015049	FLX-0015099	
FLX-0032149	1	800*410*1016		FLX-0014960		FLX-0014982	FLX-0015037	FLX-0014999	FLX-0015009	FLX-0015020 FLX-0015154	FLX-0015168	FLX-0015050	FLX-0015109	
FLX-0032150	1	800*410*1266		FLX-0014962		FLX-0014983	FLX-0015038	FLX-0014999	FLX-0015009	FLX-0015020 FLX-0015154	FLX-0015168	FLX-0015051		FLX-0015172 G FLX-0015131 D
FLX-0032151	1	800*450*1606		FLX-0014961		FLX-0014984	FLX-0015039	FLX-0015000	FLX-0025053	FLX-0015021		FLX-0015052		
FLX-0032152	1	800*500*1266		FLX-0014962		FLX-0014983	FLX-0015038	FLX-0015001	FLX-0025055	FLX-0015022		FLX-0015053	FLX-0015100	FLX-0015098 G FLX-0015401 D
FLX-0032153	2	900*370*1216		FLX-0014963	FLX-0014966	FLX-0014985	FLX-0015040	FLX-0015002	FLX-0015010	FLX-0015023 FLX-0039700		FLX-0015054	FLX-0015153	
FLX-0032154	2	1000*410*1266		FLX-0014964	FLX-0014967	FLX-0014986	FLX-0015038	FLX-0015003	FLX-0015011	FLX-0015024 FLX-0015149 FLX-0015149	FLX-0015168	FLX-0015055	FLX-0015093	FLX-0015172 G FLX-0015089 D
FLX-0032155	2	1000*410*1516		FLX-0014965	FLX-0014968	FLX-0014987	FLX-0015041	FLX-0015003	FLX-0015011	FLX-0015024 FLX-0015149 FLX-0015149	FLX-0015168	FLX-0015056	FLX-0015142	
FLX-0032156	2	1200*410*1266		FLX-0014969	FLX-0014968	FLX-0014988	FLX-0015038	FLX-0015004	FLX-0015012	FLX-0015025 FLX-0037959 FLX-0015025 FLX-0037959	FLX-0015168	FLX-0015057	FLX-0015094	FLX-0015172 G FLX-0015131 D
FLX-0032157	2	1200*410*1516		FLX-0014970	FLX-0014989	FLX-0014989	FLX-0015041	FLX-0015004	FLX-0015012	FLX-0015025 FLX-0037959	FLX-0015168	FLX-0015058	FLX-0015108	FLX-0015098 G FLX-0015131 D
FLX-0032158	2	1500*410*1266		FLX-0033702	FLX-0014990	FLX-0015038	FLX-0025049	FLX-0015013	FLX-0015016	FLX-0015026		FLX-0015059		FLX-0015172 G FLX-0015131 D
FLX-0032159	2	1000*500*1516		FLX-0014968	FLX-0014987	FLX-0014987	FLX-0015041	FLX-0015005	FLX-0015014	FLX-0015027		FLX-0015060	FLX-0015142	FLX-0035970 G FLX-0045731 D
FLX-0032160	2	1000*500*1266		FLX-0014967	FLX-0014986	FLX-0015038	FLX-0015005	FLX-0015014	FLX-0015014	FLX-0015027		FLX-0015061		FLX-0015187 G FLX-0015401 D
FLX-0032161	2	1200*500*1266		FLX-0014969	FLX-0014988	FLX-0015038	FLX-0015006	FLX-0015015	FLX-0015015	FLX-0015028 FLX-0042450	FLX-0015169	FLX-0015062	FLX-0015094	FLX-0015188 G FLX-0015401 D
FLX-0032162	2	1200*500*1766		FLX-0014971	FLX-0015134	FLX-0015042	FLX-0015006	FLX-0015015	FLX-0015015	FLX-0015028 FLX-0042450 FLX-0015028 FLX-0042450	FLX-0015169	FLX-0015063	FLX-0047381	FLX-0015155 G
FLX-0032163	2	1200*500*2016		FLX-0014972	FLX-0014991	FLX-0015043	FLX-0015006	FLX-0015015	FLX-0015015	FLX-0015029 FLX-0015171 FLX-0015029 FLX-0015171	FLX-0015169	FLX-0015064	FLX-0015192	FLX-0035970 G FLX-0045731 D
FLX-0032164	2	1500*500*1516		FLX-0014973	FLX-0014992	FLX-0015041	FLX-0015007	FLX-0015016	FLX-0015016	FLX-0015029 FLX-0015171 FLX-0015029 FLX-0015171		FLX-0015065		FLX-0035970 G FLX-0045731 D
FLX-0032165	2	1500*500*2016		FLX-0014974	FLX-0014993	FLX-0015043	FLX-0015007	FLX-0015016	FLX-0015016	FLX-0015030 FLX-0031421 FLX-0015030 FLX-0031421	FLX-0015169	FLX-0015067		FLX-0015097 G FLX-0015113 D
FLX-0032166	2	950*550*1166	FLX-0015558	FLX-0014975	FLX-0014994	FLX-0015044	FLX-0015195	FLX-0015017	FLX-0015017	FLX-0015031 FLX-0036343 FLX-0015031 FLX-0036343	FLX-0015169	FLX-0015067		FLX-0015097 G FLX-0015113 D
FLX-0032167	2	1100*550*1416	FLX-0014958	FLX-0014976	FLX-0014995	FLX-0015045	FLX-0015008	FLX-0015018	FLX-0015018	FLX-0015031 FLX-0036343 FLX-0015031 FLX-0036343	FLX-0015169	FLX-0015068		FLX-0015090 G FLX-0015157 D
FLX-0020700	2	110*550*1606					FLX-0015039	FLX-0015008	FLX-0015018	FLX-0015031 FLX-0036343	FLX-0015169			
FLX-0032168	2	1200*550*1966	FLX-0033699	FLX-0014979	FLX-0014996	FLX-0014996	FLX-0015046		FLX-0034178	FLX-0034179	FLX-0015169	FLX-0015069		FLX-0015140 G
FLX-0032169	2	1600*550*1416	FLX-0033700	FLX-0014977	FLX-0014997	FLX-0015045	FLX-0025051	FLX-0015019	FLX-0015019	FLX-0015032	FLX-0015033	FLX-0015070		FLX-0015090 G FLX-0015157 D
FLX-0032170	2	1200*600*2016		FLX-0014972	FLX-0014991	FLX-0015043				FLX-0048167		FLX-0015071		FLX-0015181 G
FLX-0032171	2	1500*600*2016		FLX-0014974	FLX-0014993	FLX-0015043	FLX-0031462	FLX-0015124				FLX-0015072		FLX-0015181 G
FLX-0032172	2	1800*600*2016		FLX-0014978	FLX-0014998	FLX-0015043	FLX-0015132	FLX-0031167	FLX-0031167	FLX-0017879 FLX-0047379		FLX-0015073		FLX-0015181 G
FLX-0032173	2	1200*800*2016		FLX-0014972	FLX-0014991	FLX-0015043						FLX-0015074	FLX-0015192	FLX-0015135 G FLX-0039698 D FLX-0015135 G FLX-0039698 D
FLX-0032174	2	1500*800*2016		FLX-0014974	FLX-0014993	FLX-0015043						FLX-0015075		FLX-0015135 G FLX-0039698 D
FLX-0032175	2	1800*800*2016		FLX-0014978	FLX-0014998	FLX-0015043						FLX-0015076		FLX-0015135 G FLX-0039698 D
FLX-0032176	2	1200*1100*1966	FLX-0033701	FLX-0014979	FLX-0033703	FLX-0015046				FLX-0037506	FLX-0015034	FLX-0015077		

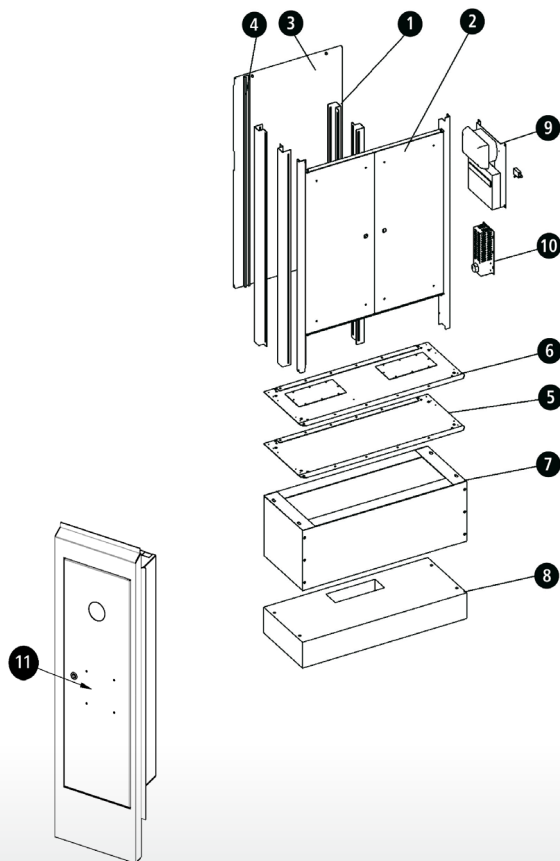

alu

gamme standard



Finition et protection :

Revêtement : résine polyester thermo laquée suivant trois types de finitions; texturé, lisse ou crépi.

Gamme de coloris RAL sur demande.











Protection standard: IP 44 IK 10.

Protection IP renforcée et kit anti-vandalisme sur demande.

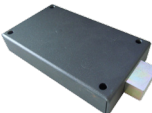
Titres	Normes	Résultats
Adhérence selon	NFT 17082 (74)	> 2 MPa
Tenue au brouillard salin	A05-101 (91)	720 heures
Vieillessement artificiel	NFT 30049 (85)	50 cycles de 4h
Résistance à l'abrasion	ASTM D968 (93)	75 L de sable
Emboutissage Ericksen	ISO 1520	> 5 mm
Résistance aux chocs	EN 6272	1kg/50 cm

Propriétés mécaniques :

Titres	Normes	Résultats	Panneaux ERDF	Désignation
tenue aux chocs	EN 62262	IK 10	GRL-006980E	Panneau de contrôle 500x250 mono C/C Taille 0 (HN 62 S 80)
renversement		> 150 daN	FLX-0034886	Panneau de contrôle 800x250 tetra C/C TAILLE 0 (HN 62 S 80)
arrachement de la porte		> 90 daN	FLX-0037495	Panneau de contrôle CTBX ERDF 250x800 mono C/C TAILLE 0
surcharge du toit		500 kg / m ²	FLX-0000090	Panneau de contrôle CTBX ERDF 250x800 tetra C/C TAILLE 0
endurance mécanique		300 cycles (ouv., ferm.)	FLX-0015175	Panneau CTBX nu 250x800x15

									
9 - Eclairage	10- Résistance thermostatée 250 W	10- Résistance thermostatée 500 W	10-Verrou triangle cadénassable	10-Serrure agréée EDF sans canon	10-Numéro de clé	10-Bouton papillon à clé	10-Serrure bec de canne à clé	10-Serrure à clé affleurante	Ecroû rails D1
FLX-00150078	FLX-0015035	FLX-0015036	FLX-0000048	THIRARD FLX-0015203	405	FLX-0015200			FLX-0000006 (M5)
				DENY FLX-0015230	455		FLX-0015201		FLX-0025826 (M6)
					2432A			FLX-0015202	FLX-0000007 (M8)

alu

gamme standard



Sélection de l'armoire de base selon :

Volume des matériels à intégrer.
Fixations au sol.

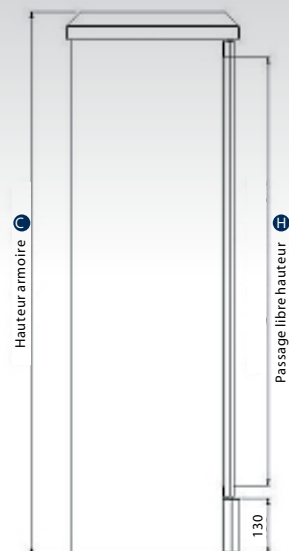
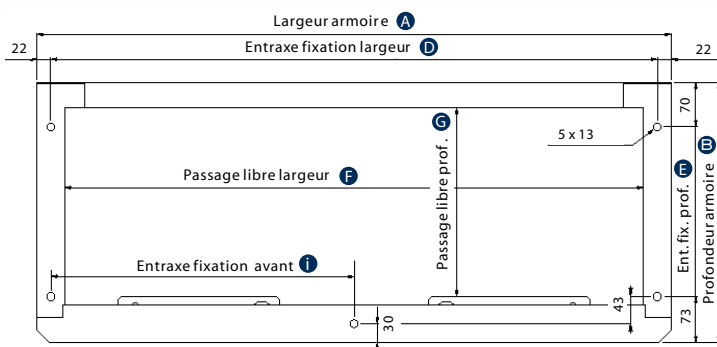

Installation

Sur radier béton : chevilles plastiques avec vis tire-fond de 10 x 60 minimum.
Pour socle béton ou alu : réaliser un remblai de gravier ou de concassé compacté.

Références, options et dimensions :

	A largeur	B profondeur	C hauteur	D	E	F	G	H	Porte
FLX-0032146	600	300	1016	557	157	513	187	750	278
FLX-0032147	800	300	1016	757	157	713	187	750	378
FLX-0032148	600	410	1016	557	267	513	297	750	278
FLX-0032149	800	410	1016	757	267	713	297	750	378
FLX-0032150	800	410	1266	757	267	713	297	1000	378
FLX-0032151	800	450	1606	757	307	713	337	1340	378
FLX-0032152	800	500	1266	757	357	713	387	1000	378
FLX-0032153	900	370	1216	857	227	813	257	950	428
FLX-0032154	1000	410	1266	957	267	913	297	1000	478
FLX-0032155	1000	410	1516	957	267	913	297	1250	578
FLX-0032156	1200	410	1266	1157	267	1113	297	1000	578
FLX-0032157	1200	410	1516	1157	267	1113	297	1250	728
FLX-0032158	1500	410	1266	1457	267	1413	297	1000	478
FLX-0032159	1000	500	1516	957	357	913	387	1250	478
FLX-0032160	1000	500	1266	957	357	913	387	1000	578
FLX-0032161	1200	500	1266	1157	357	1113	387	1000	578
FLX-0032162	1200	500	1766	1157	357	1113	387	1500	578
FLX-0032163	1200	500	2016	1157	357	1113	387	1750	578
FLX-0032164	1500	500	1516	1457	357	1413	387	1250	728
FLX-0032165	1500	500	2016	1457	357	1413	387	1750	728
FLX-0032166	950	550	1166	907	407	863	437	900	453
FLX-0032167	1100	550	1416	1057	407	1013	437	1150	528
FLX-0020700	1100	550	1606	1057	407	1013	437	1340	528
FLX-0032168	1200	550	1966	1557	407	1113	437	1700	578
FLX-0032169	1600	550	1416	1557	407	1513	437	1150	778
FLX-0032170	1200	600	2016	1157	457	1113	487	1750	578
FLX-0032171	1500	600	2016	1457	457	1413	487	1750	728
FLX-0032172	1800	600	2016	1757	457	1713	487	1750	878
FLX-0032173	1200	800	2016	1157	657	1113	687	1750	578
FLX-0032174	1500	800	2016	1457	657	1413	687	1750	728
FLX-0032175	1800	800	2016	1757	657	1713	687	1750	878
FLX-0032176	1200	1100	1966	1157	957	1113	987	1750	578